

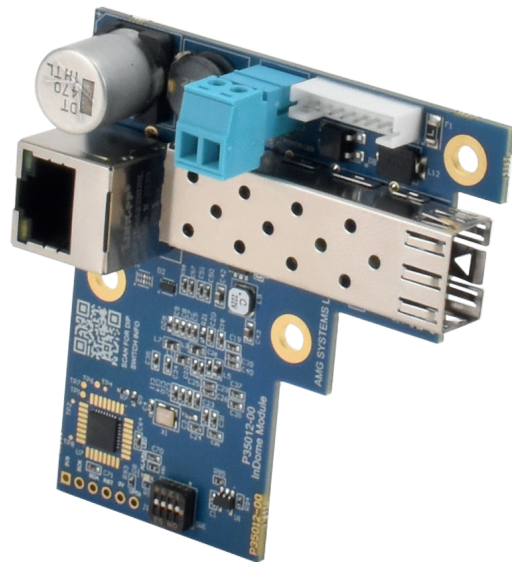





# AMG260P/KF INDUSTRIAL MEDIA CONVERTER FOR KEENFINITY / BOSCH CAMERA HOUSINGS



## Industrial Ethernet Solutions

AMG's /KF PCB media converter modules provide a multirate 100Mb/Gigabit Ethernet uplink over fiber via the SFP port and are installed in the Keenfinity / Bosch camera surveillance cabinets. Additional features are supported by user-configurable DIP switches for advanced functionality.



 Gigabit x1	 100/1000 x1	 Features DIP Switch	 Temp -40°C~+75°C	 Mounting PCB	 NDAA/TAA Compliant
---	--	--	---	---	---

[ AMG260P-1G-1S/KF ]

### / OVERVIEW

The AMG260P/KF series of industrial PCB media converters are ideally suited for connecting Keenfinity / Bosch IP cameras to Ethernet networks over long distances using all types of fiber through the integrated SFP port. Fiber connectivity is determined by separate SFP device selection, providing application and site flexibility. Designed to be fully compatible with the VG4-A-P, NDA-U-P & NBA-7070-PA series of camera surveillance cabinets from Keenfinity / Bosch complete with all required mounting and connection accessories.

The AMG260P/KF is designed to be a direct drop in alternative to the legacy Bosch VG4-SFPSCKT (F.01U.142.529) media converter module while providing additional smart functionality and SFP options.

User selectable DIP switches allow for configuration of the intelligent link fault pass-through feature for remote end failure detection as well as remote device reset to allow media converter reboots from the control room and 250M extended distance mode on the RJ45 port.

The AMG260P/KF models are fully compatible with all of the AMG250/260/260B/260M model ranges as well as many other 3rd party media converters and switches.

### / FEATURES

- Designed for the Keenfinity / Bosch surveillance cabinets VG4-A-P, NDA-U-P & NBA-7070-PA series complete with mounting kit and accessories for simple field installation
- -40°C to +75°C temperature maintains performance in extreme conditions
- All SFP ports are multirate 100Mb/Gigabit – support single and multimode, single or dual fiber options up to 120Km
- DIP switch selection of link fault pass-through, remote device reset and extended distance modes
- Dual power input connection options for direct Keenfinity / Bosch PCB connection cable or 2-pin removable screw terminal connector
- Auto-Negotiation (802.3u) – automatically determines the best connection speed
- Designed in the USA & UK. Manufactured in the United Kingdom
- AMG Lifetime Support Warranty

# Specifications.

## Standards.

IEEE802.3i	10Base-T
IEEE802.3u	100Base-TX & 100Base-FX
IEEE802.3ab	1000Base-T
IEEE802.3z	1000Base-X
IEEE802.3x	Flow Control
Jumbo Frames	9.2Kbytes
Address Table	2K MAC Entries

## Interface.

LED Indicators	1x Power SFP Link/Activity RJ45 Link/Activity Alarm
RJ45 Ports	1x 10/100/1000T(X) RJ45 with Auto MDI/MDI-X and 2 kV Isolation Protection
SFP Slot	1x 100/1000FX SFP
Power	1x 2-way Screw Terminal 1x 8-way 2.0mm JST <small>(B8B-PH-K-S)</small>

## Switches.

Switch	1x 4 Position DIP Switch
Switch Functions	Link Fault Pass-Through Mode Remote Reset Mode Extended Distance Mode

## Power.

Power Inputs	1
Operating Voltage	12-24V <sub>DC</sub> or 24V <sub>AC</sub>
Power Consumption	2W Max
Protection	Reverse Polarity Overload Current

## Packaging.

Shipping Weight	0.20kg / 0.44lb
Dimensions:	(W x D x H) 220 x 170 x 40 mm 8.66 x 6.69 x 1.57 in

## Mechanical.

Mounting Bracket	Steel
Dimensions:	(W x D x H)
PCB Only	71 x 21 x 74 mm 2.80 x 0.83 x 2.91 in
PCB With Bracket	95 x 32 x 79 mm 3.74 x 1.26 x 3.11 in
IP Rating	N/A (IP Rating Determined By Enclosure)
Installation	Keenfinity / Bosch Camera Surveillance Cabinets
Weight	0.04kg / 0.09lb

## Environmental.

Operating Temp.	-40 to +75°C / -40 to +167°F
Storage Temp.	-40 to +85°C / -40 to +185°F
Humidity	5% to 95% (non-condensing)
MTBF	>500,000 hours
MTBF Standard	Telcordia SR-332 GF 30°C
Heat Dissipation	7 BTU/h
Cooling	Passive Cooling
Noise Level	0 dBA

## Regulatory.

Safety	IEC/EN 62368-1
EMI	EN 55032 Class A CISPR 32 FCC Part 15B Class A
EMS	EN 55035 / CISPR 35 EN 61000-4-2 <small>(ESD)</small> EN 61000-4-3 <small>(RS)</small> EN 61000-4-4 <small>(EFT)</small> EN 61000-4-5 <small>(Surge)</small> EN 61000-4-6 <small>(CS)</small> EN 61000-4-8 <small>(PFMF)</small>
Shock	IEC 60068-2-27
Vibration	IEC 60068-2-6
Environmental	Reach RoHS WEEE
Supply Chain	NDAA & TAA Compliant

Designed to meet NEMA TS2 & EN 50121-4

# Compatibility.

## Keenfinity / Bosch Compatible Surveillance Cabinets

NDA-U-PA0	Surveillance Cabinet 24VAC (F.01U.324.947)
NDA-U-PA1	Surveillance Cabinet 120VAC (F.01U.324.948)
NDA-U-PA2	Surveillance Cabinet 230VAC (F.01U.324.949)
NDA-U-PSU0	PSU 24VAC For NDA-7100PEN/PENF (F.01U.411.639)
NDA-U-PSU1	PSU 120VAC For NDA-7100PEN/PENF (F.01U.411.640)
NDA-U-PSU2	PSU 230VAC For NDA-7100PEN/PENF (F.01U.411.641)
NDA-U-PSU0H	PSU IR 24VAC (F.01U.425.481)
NDA-U-PSU1H	PSU IR 120VAC (F.01U.425.482)
NDA-U-PSU2H	PSU IR 230VAC (F.01U.425.483)
NBA-7070-PA0	Direct-Mount Surveillance Cabinet 24VAC (F.01U.405.368)
NBA-7070-PA1	Direct-Mount Surveillance Cabinet 120VAC (F.01U.405.369)
NBA-7070-PA2	Direct-Mount Surveillance Cabinet 230VAC (F.01U.405.370)
VG4-A-PA0	Pendant Arm Power Box 24VAC For AUTODOME (F.01U.261.373)
VG4-A-PA1	Pendant Arm Power Box 120VAC For AUTODOME (F.01U.261.374)
VG4-A-PA2	Pendant Arm Power Box 230VAC For AUTODOME (F.01U.261.375)
VG4-A-PSU0	PSU 24VAC For AUTODOME, MIC7000 (F.01U.261.376)
VG4-A-PSU1	PSU 120VAC For AUTODOME, MIC7000 (F.01U.261.377)
VG4-A-PSU2	PSU 230VAC For AUTODOME, MIC7000 (F.01U.261.378)

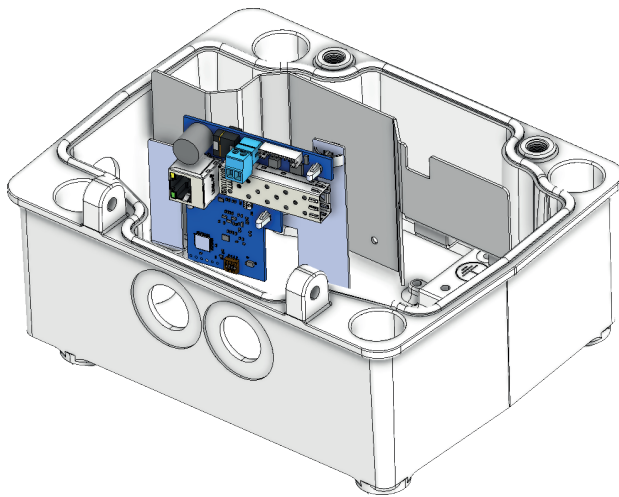

# Legacy Alternatives.

## Bosch to AMG - Alternative Legacy Parts Matrix

Legacy Bosch Part Code	AMG Alternative Part Code	AMG Device Type	Notes
VG4-SFPSCKT (F.01U.142.529)	AMG260P-1G-1S/KF	PCB Module	
CNFE2MC/IN (F.01U.136.545)	AMG260M-1G-1S	Mini DIN/Wall Mount	PSU Not Included Order AMGPSU-I12-P24A-K
	AMG260-1G-1S	Full Size DIN/Wall Mount	PSU Not Included Order AMGPSU-I12-P24A-K
	AMG260B-1G-1S	Blade Card	
SFP-2 (F.01U.136.537)	SFP-MM-100M-FX2-31	SFP Module (MM, 2 Fibers)	
SFP-3 (F.01U.136.538)	SFP-SM-100M-LX20-31	SFP Module (SM, 2 Fibers)	
SFP-25 (F.01U.136.541)	SFP-MM-100M-BX2-31	SFP Module (MM, 1 Fiber)	AMG SFP Uses LC Type Connectors Legacy SFP Uses SC Type Connectors
SFP-26 (F.01U.136.542)	SFP-MM-100M-BX2-55	SFP Module (MM, 1 Fiber)	AMG SFP Uses LC Type Connectors Legacy SFP Uses SC Type Connectors
C1-IN (F.01U.136.543)	AMG2036-RP-AD	Blade 19inch Rack, 1U	
C1-BP (F.01U.136.544)	AMG2036-BP1	Blade 1 Slot Blank Panel	

## Part Numbers.

### 1+1 Industrial Media Converter Boards

AMG260P-1G-1S/KF      1 x 10/100/1000BaseT(x) RJ45, 1 x 100/1000BaseFx SFP, PCB, Keenfinity/Bosch Cabinets

## Included Accessories.

- Mounting Bracket      Steel Mounting Bracket For Keenfinity / Bosch Camera Surveillance Cabinets with 2x M4x5mm Fixing Screws
- PCB Mounts            3x PCB Nylon 35mm Snap-In Latch Standoffs for Mounting PCB to the Bracket
- Power Cable            Custom 5-Wire Power Cable, JST PHR-8 to JST PHR-5 Connectors, 110mm (4.3in) Length
- Ethernet Cable        Cat5e Ethernet Cable For Camera To Media Converter Connection, Black, 300mm (11.8in) Length



## Optional Accessories.

SFP Modules      100Mb & 1Gb Optical/Copper Modules see separate list, need to be ordered separately



*In a continuing effort to improve and advance technology, product specifications are subject to change without notice. Please visit [www.amgsystems.com](http://www.amgsystems.com) for the latest product specifications.*